



Creating Dynamic Blocks in AutoCAD – Only You Can Prevent Bloated Block Libraries

Tracy Chadwick

Hutchinson Community College – Computer Drafting Instructor / Coordinator

@tracy_chadwick

Class summary

AutoCAD software's Dynamic Blocks gives you the ability to save time while reducing the size of your block library. Do you have multiple blocks with slight variations between them? Let's turn them into a single block that we can stretch, rotate, and more.

Key learning objectives

At the end of this class, you will be able to:

- Create Dynamic Blocks with the following abilities: stretch, mirror, array, rotate, align, multiple insertion points
- Limit block variations through lists, increments, block tables, and lookup actions
- Apply constraints and parameters to control block behavior
- Extract dynamic block properties to AutoCAD tables and Excel spreadsheets

Who are you?

- I have already created Dynamic Blocks but I am looking for some tips and tricks.
- I have never created a Dynamic Block before and I am here to learn how to create my first Dynamic Block!
- The class I really wanted was full.

Why Dynamic Blocks?

Simplify your block library.

Modify blocks quickly and easily.

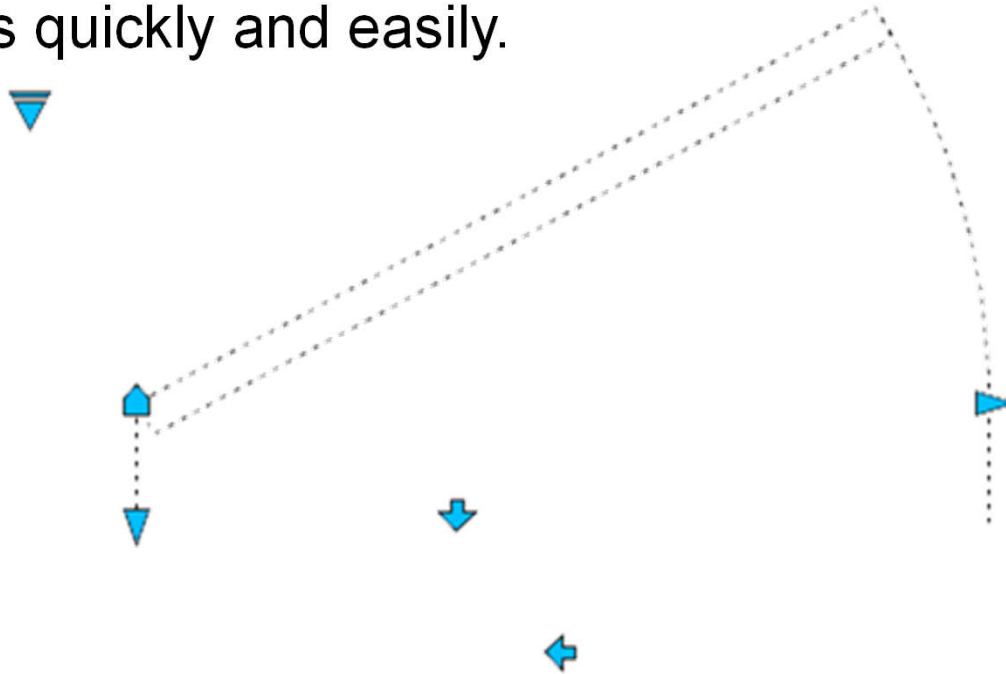

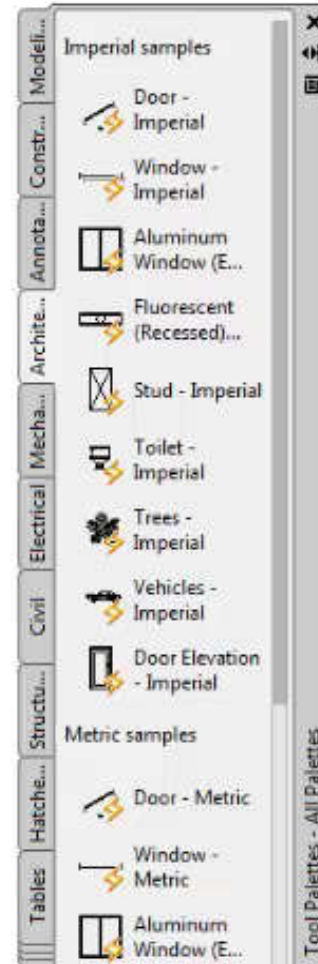

W

Block Creation Environment

- Double-click on a block (with exceptions...)
- Select the block and right-click

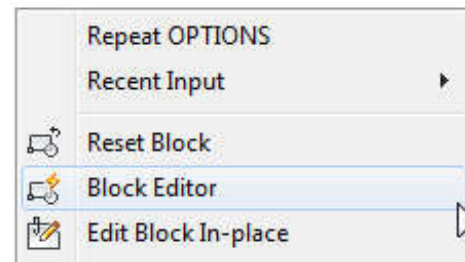

- Home > Block > Edit

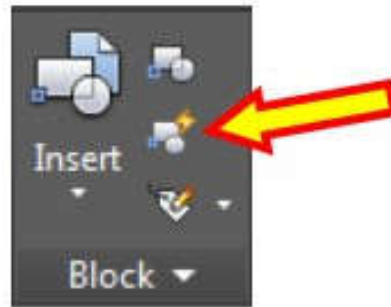

Block Creation Environment

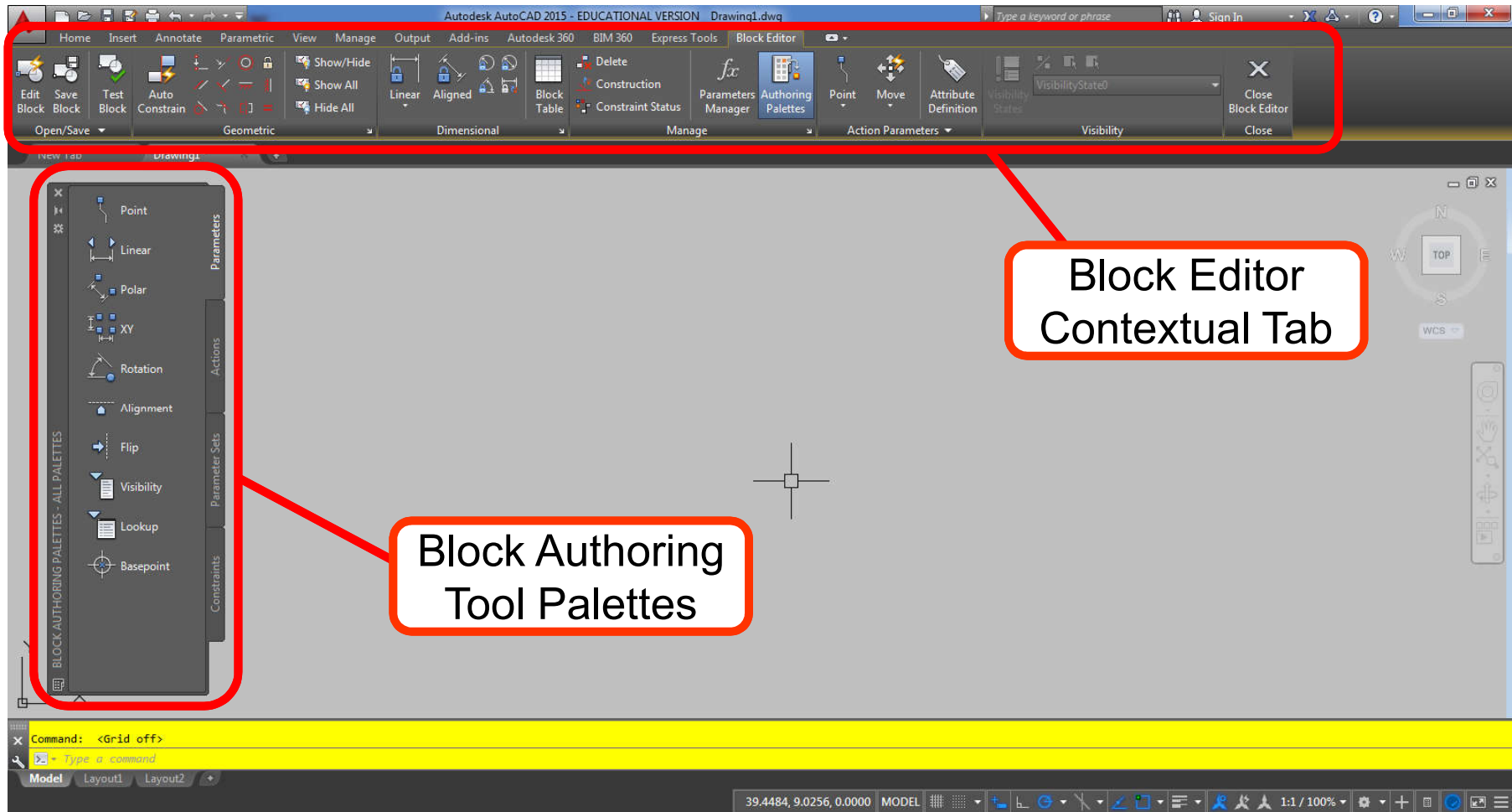

Block Editor
Contextual Tab

Block Authoring
Tool Palettes

Block Authoring Palettes

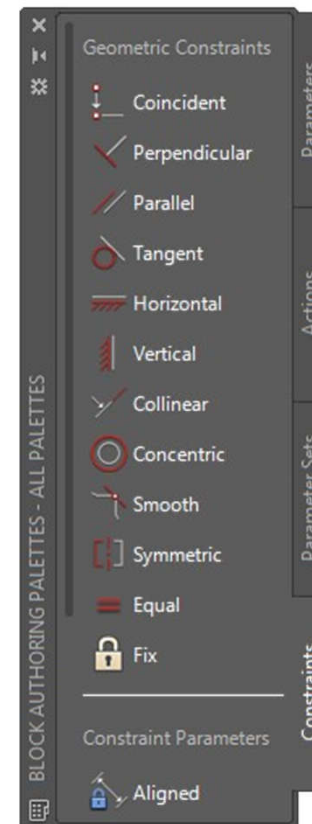
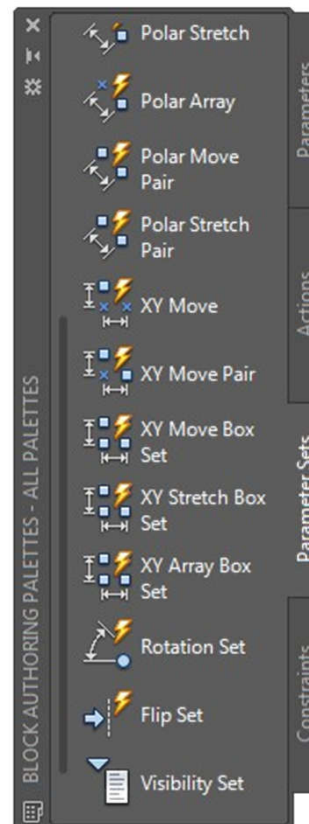
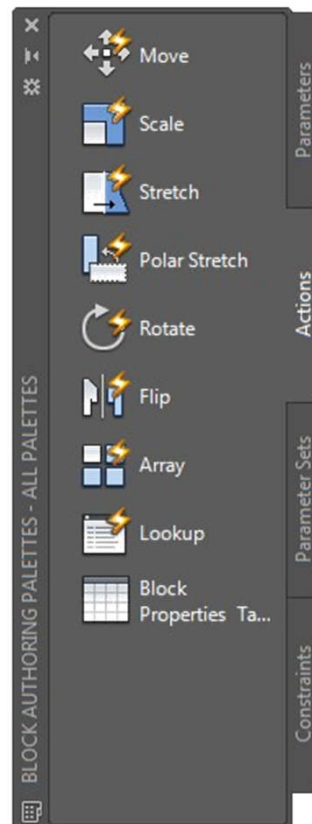
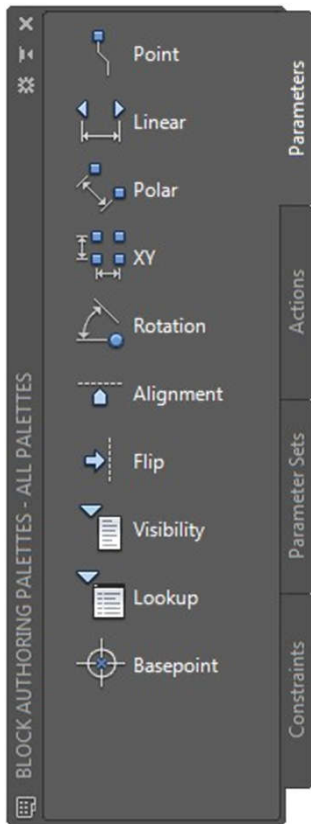

**Create Dynamic Blocks with
the following abilities:
stretch, mirror, array, rotate,
align, and multiple insertion
points**

Create Additional Insertion Points

- Use the Point Parameter
- No Action Necessary
- Press <Ctrl> key to cycle between insertion points during insertion.

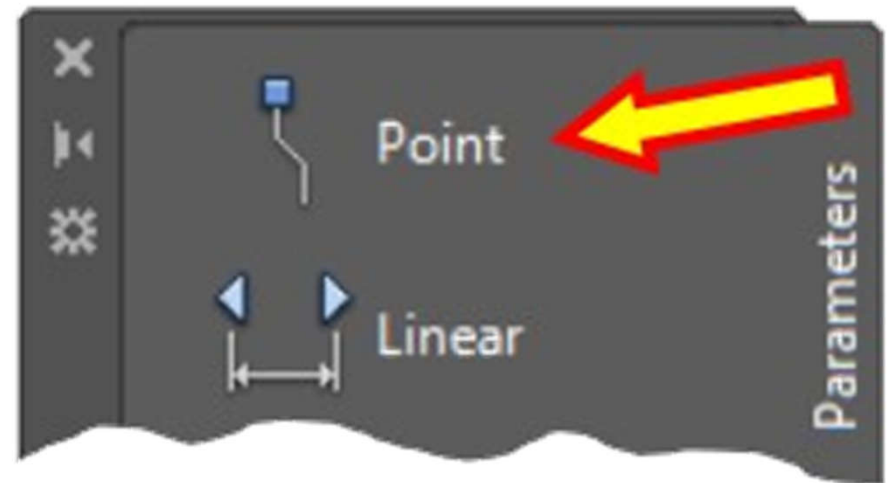

Insertion Points: Demonstration

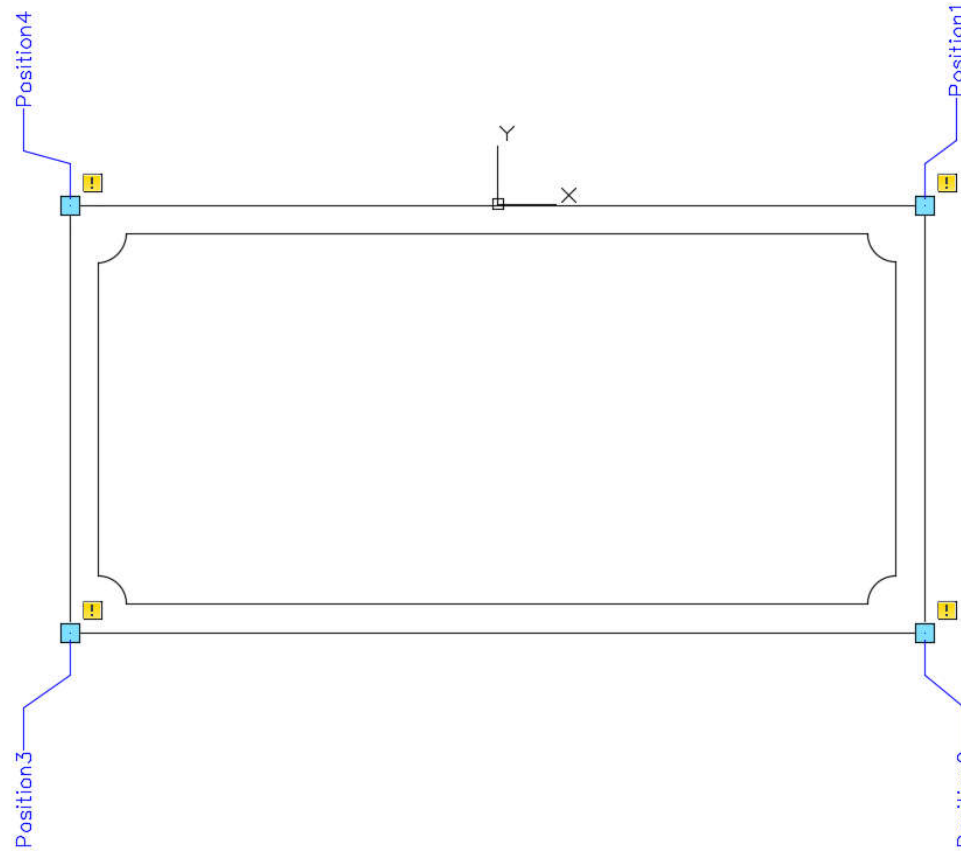

Create an Alignment Grip

- Use the Alignment Parameter
- No Action Necessary

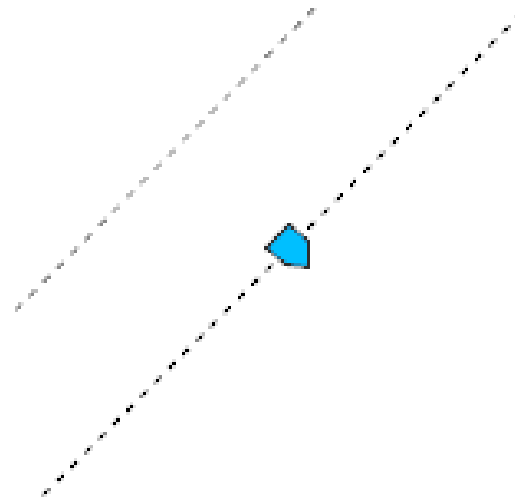

Alignment Grip: Demonstration

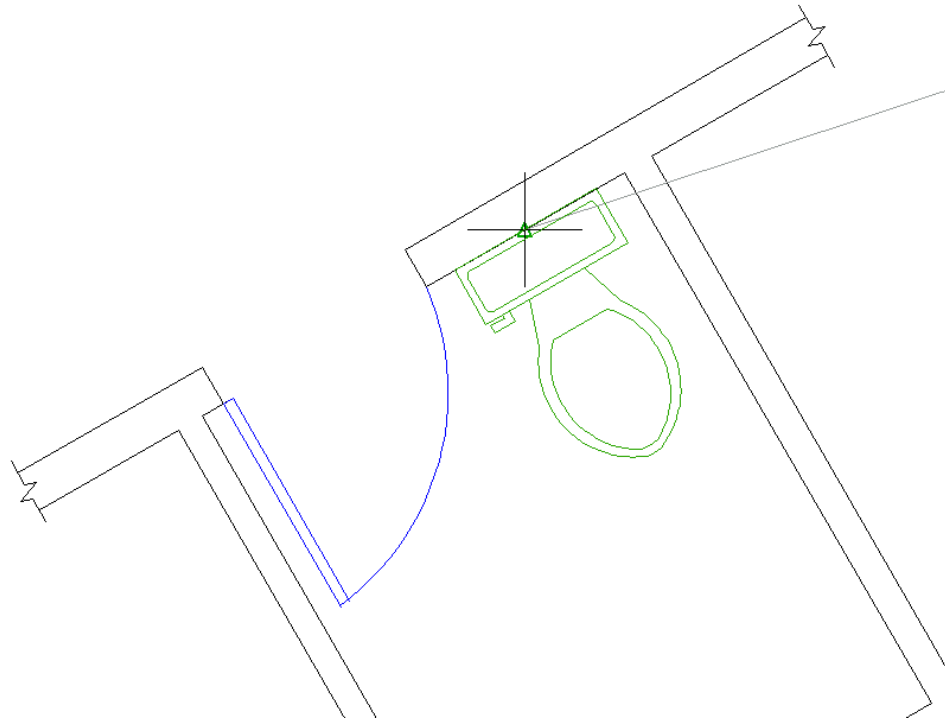

Create a Flip Grip

- Use the Flip Parameter
- Exclamation = Action Needed
- Use the Flip Action

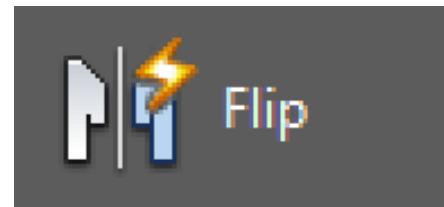

Flip Grip: Demonstration

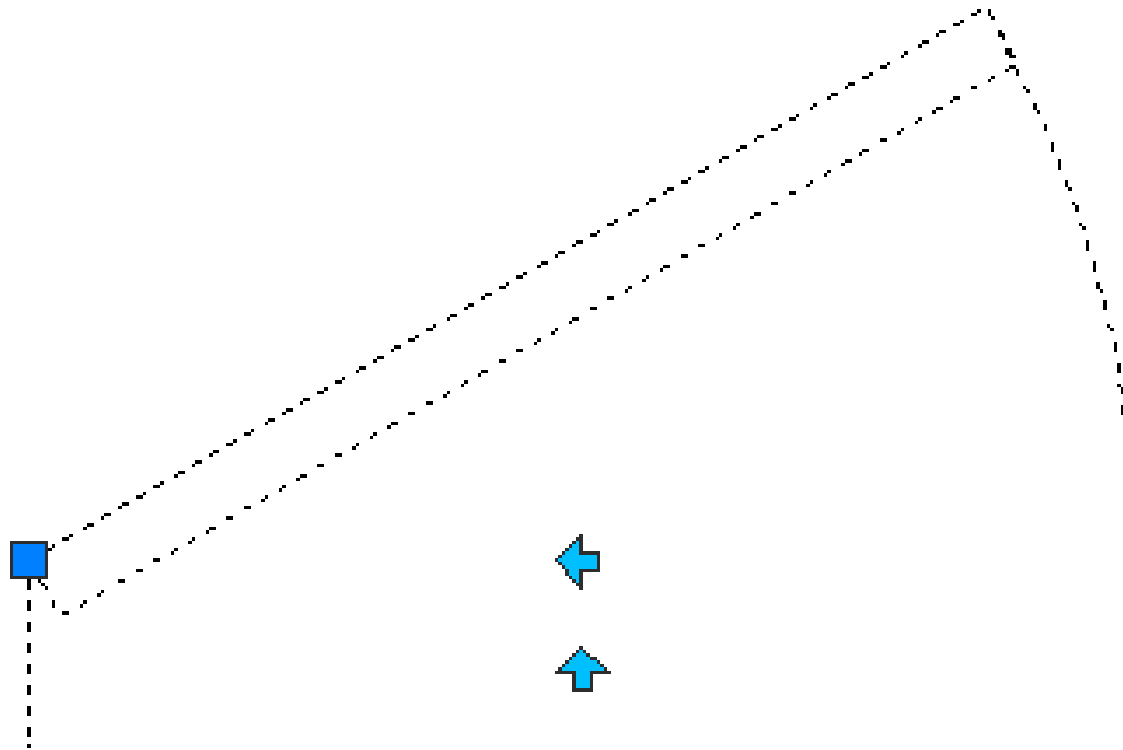

Adding the Rotation Action

- Use the Rotation Set to save steps
- Add a Selection Set to the Action

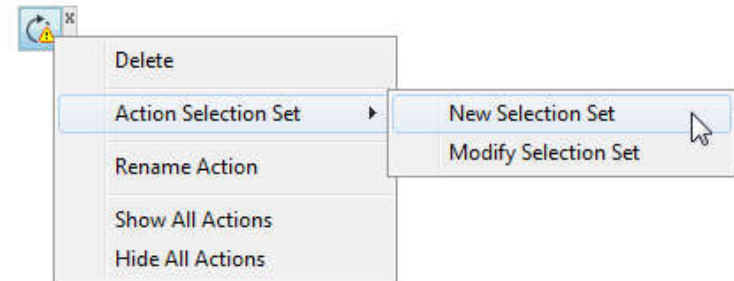
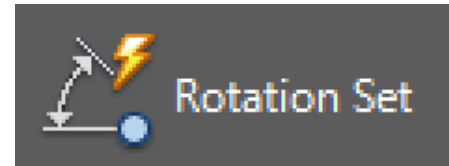

Rotation Set: Demonstration

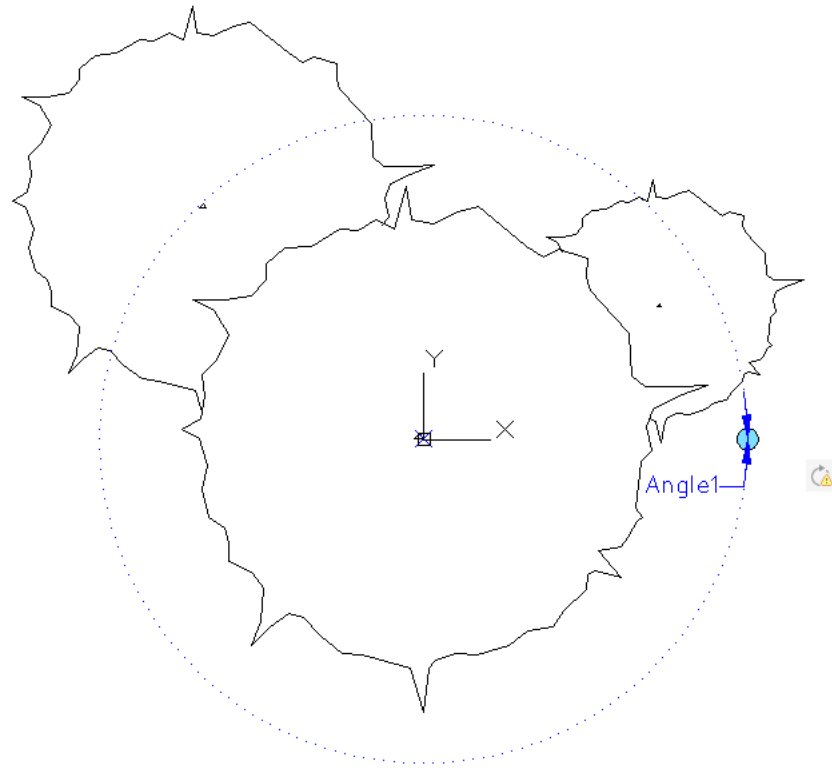

Adding the Visibility Grip

- Use the Visibility Parameter
- Use the Visibility Panel
- Create new states while hiding all others

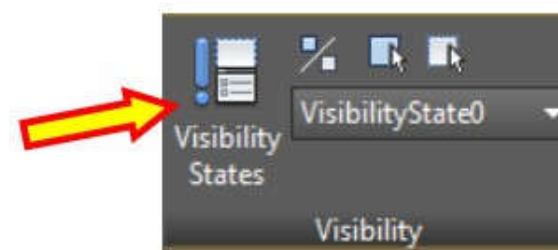
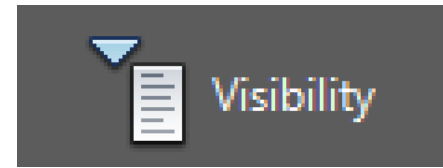

Visibility: Demonstration

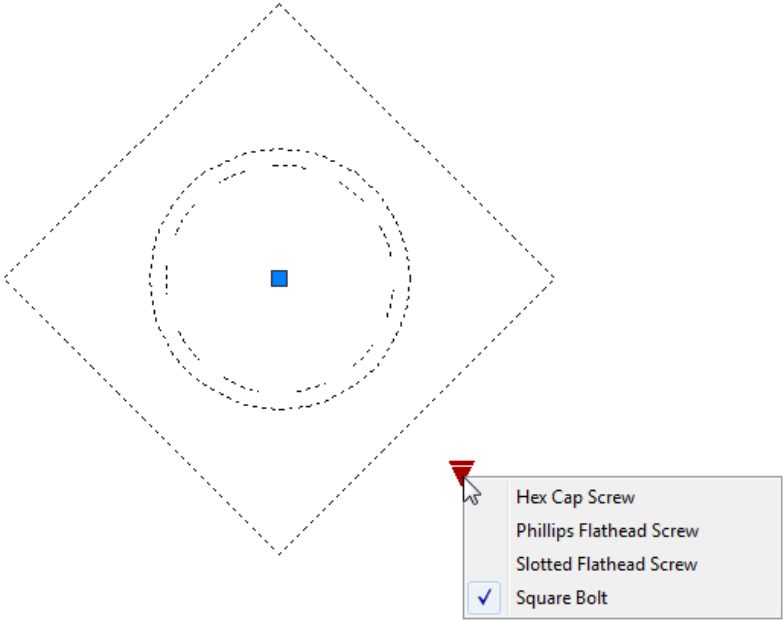

Limit block variations through lists, increments, block tables, and lookup actions

Adding the Stretch Action and Limiting with Lists

- Use the Linear Parameter
- Use the Stretch Action
- Use Properties to create an allowable list of values.

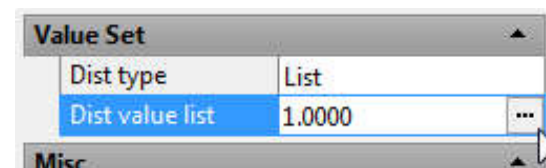
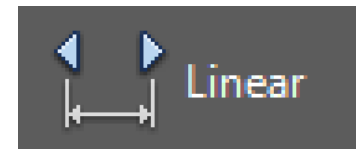

Stretch/List: Demonstration

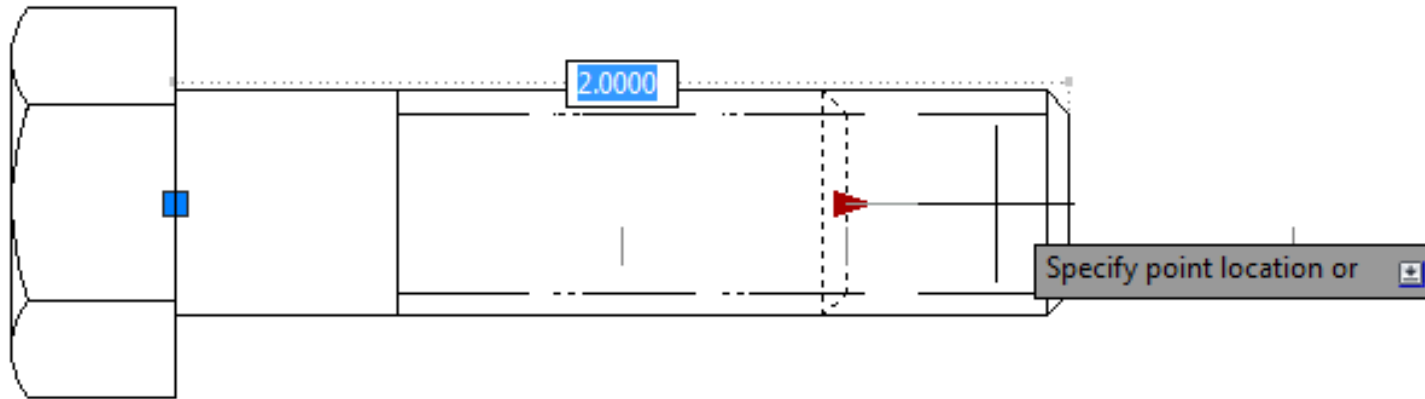

Adding the Array Action and Limiting with Increments

- Use the Linear Parameter
- Use the Array Action
- Use the Increment option to limit values

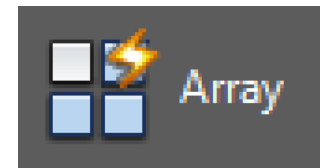
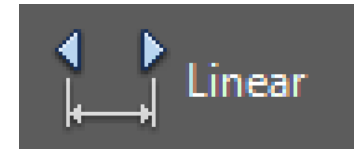

Value Set	
Dist type	Increment
Dist increment	9.0000
Dist minimum	0.0000
Dist maximum	

Array/Increment: Demonstration

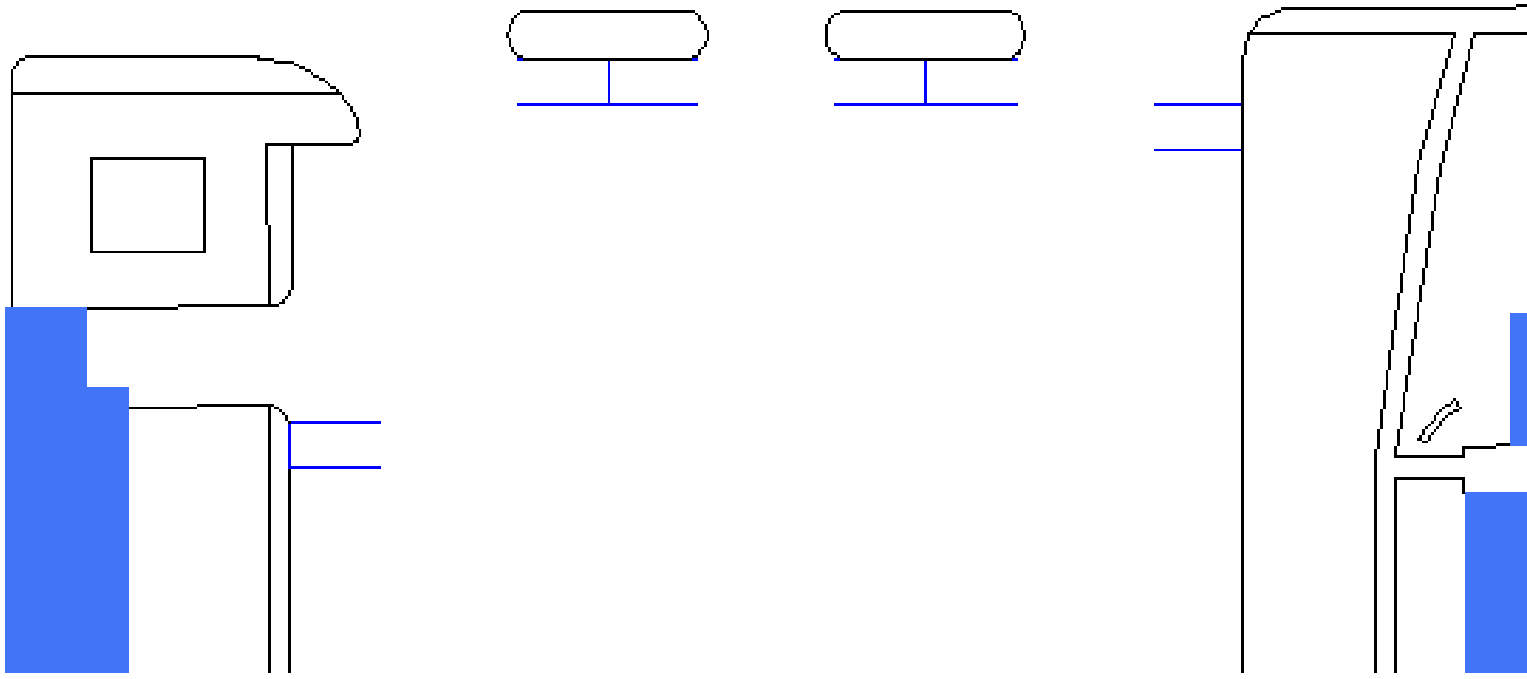

Adding the Lookup Action

- Use the Lookup Parameter
- Use the Lookup Action
- Create a list of Lookup Values

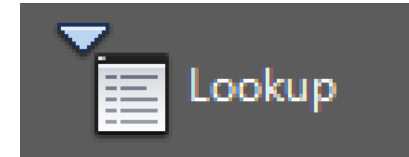

Input Properties		Lookup Properties	
	Distance1	Lookup1	
	1.0000	1/2 x	1.00
	1.5000	1/2 x	1.50
	2.0000	1/2 x	2.00
	2.5000	1/2 x	2.50
▶	3.0000	1/2 x	3.00

Lookup: Demonstration

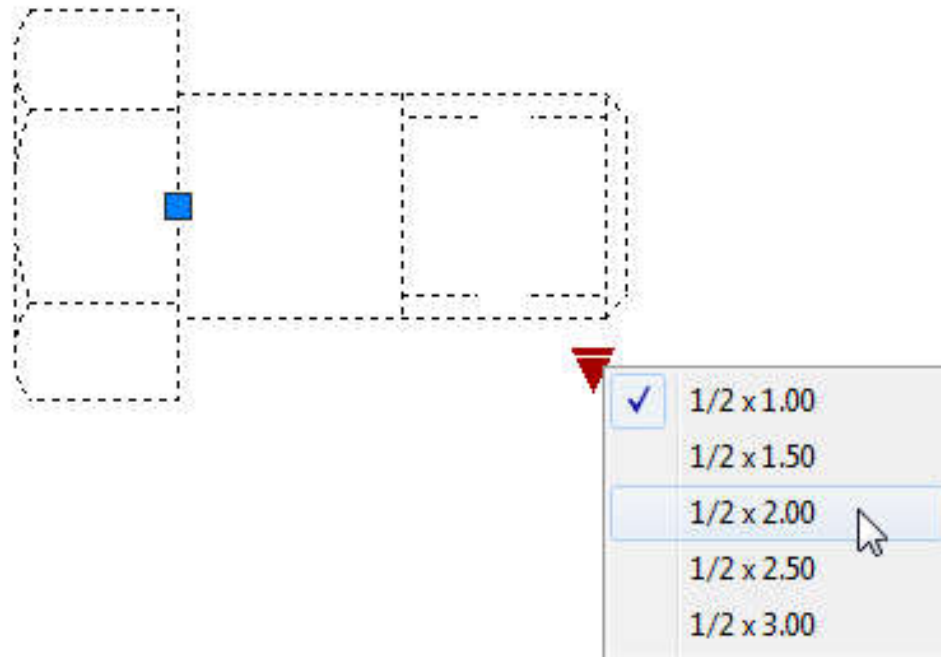

Apply constraints and parameters to control block behavior

Using Parameters

- Constrain Geometry
- Create Named Parameters
- Create a block table to drive Parameters

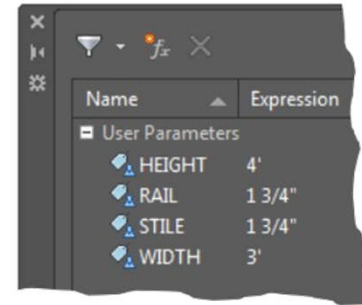

WIDTH	HEIGHT
36.0000	36.0000
36.0000	48.0000
36.0000	60.0000
48.0000	48.0000
48.0000	60.0000
60.0000	60.0000

Parameters: Demonstration

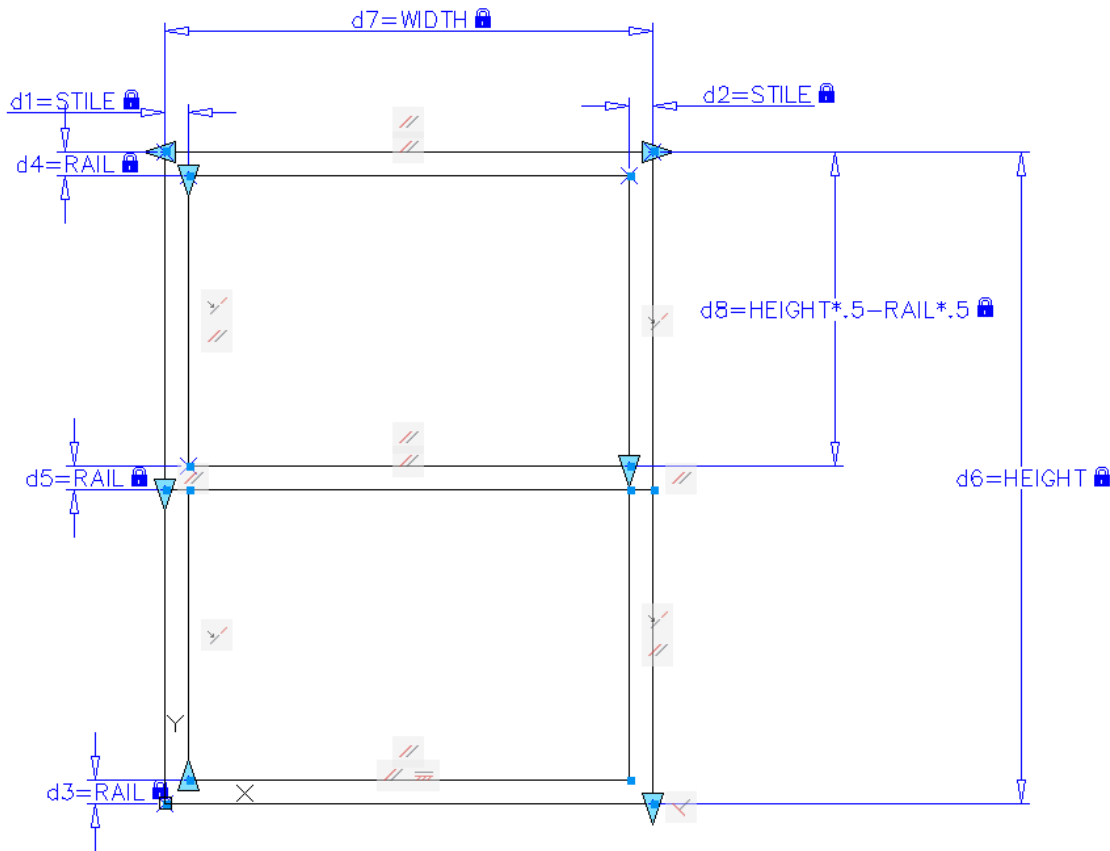

Extract dynamic block properties to AutoCAD tables and Excel spreadsheets

Extracting Data

- Insert >> Linking & Extraction >> Extract Data

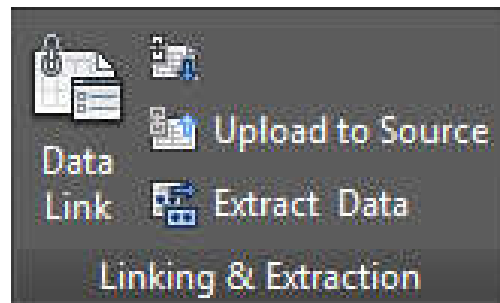

- Insert Table

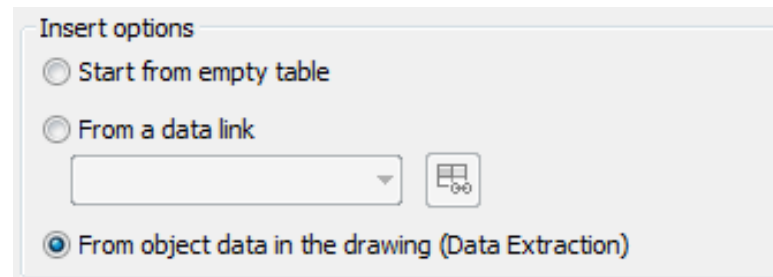

Extracting Data: Demonstration

Door Schedule				
MARK	TYPE	WIDTH	HEIGHT	MFG
100	Single-Flush	3'-4"	7'-0"	Jeld Wen
101	Single-Flush	2'-8"	7'-0"	Jeld Wen
102	Single-Flush	2'-8"	6'-8"	AMC
103	Single-Flush	2'-6"	6'-8"	Jeld Wen
104	Single-Flush	2'-6"	6'-8"	Jeld Wen

Conclusion

- Now it's your turn! Take these skills back to work and improve your productivity!
- Questions?
 - @tracy_chadwick
 - chadwickt@hutchcc.edu

How did I do?

- Your class feedback is critical. Fill out a **class survey** now.
- Use the AU mobile app or fill out a class survey online.
- Give feedback after each session.
- AU speakers will get feedback in real-time.
- **Your feedback results in better classes and a better AU experience.**





Autodesk is a registered trademark of Autodesk, Inc., and/or its subsidiaries and/or affiliates in the USA and/or other countries. All other brand names, product names, or trademarks belong to their respective holders. Autodesk reserves the right to alter product and services offerings, and specifications and pricing at any time without notice, and is not responsible for typographical or graphical errors that may appear in this document. © 2016 Autodesk, Inc. All rights reserved.

© 2016 Autodesk. All rights reserved.

